

DVD14CSBN

INSTRUCTIUNI DE INSTALARE

SUPPORT DE PERETE (Sticla) PENTRU DVD/DVB

SUPPORT DE PERETE DIN STICLA PENTRU DVD/DVB
 Produsul trebuie montat de un profesionist.

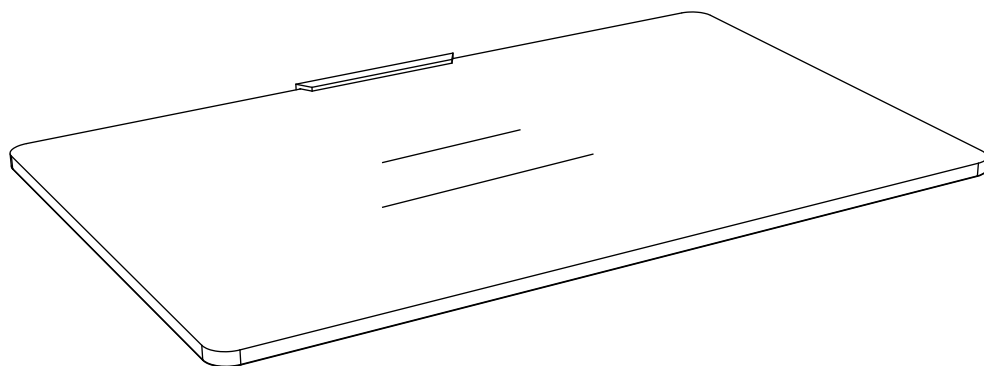

----- INSTALLATION SPECIFICATION:

①

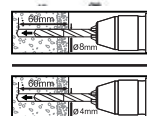

Perete de ciment



Perete de lemn

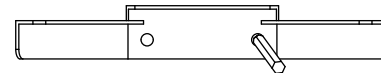

—Efectuati gauri de $\Phi 6$ cu o masina de gauri peste insemnari. Adancimea gaurilor ar trebui sa fie de cel puțin 60mm.

②

A		2
B		2
C		2

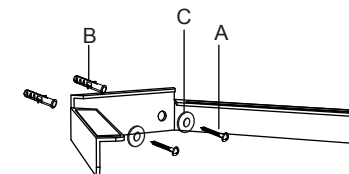

—Utilizati piesele A si B pentru a asambla stand-ul de sticla DVD/DVB pe perete.

③

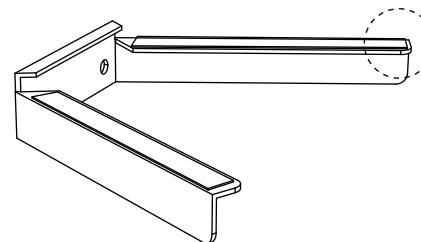
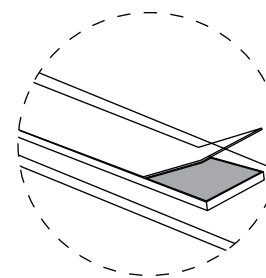

④

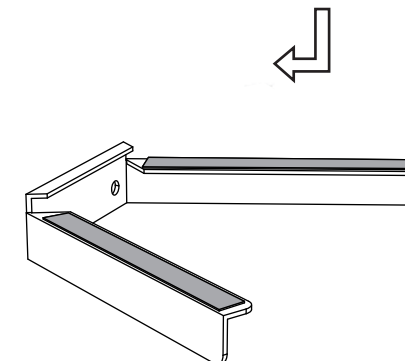
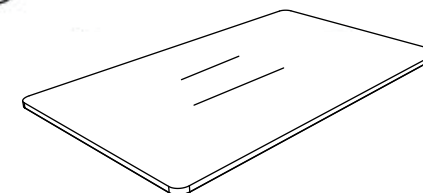

DVD14CSBN SZERELÉSI ÚTMUTATÓ

ÜVEGPOLC DVD/DVB-HEZ

ÜVEGPOLC DVD/DVB - HEZ

A konzol felszereléséhez hívjon szakembert

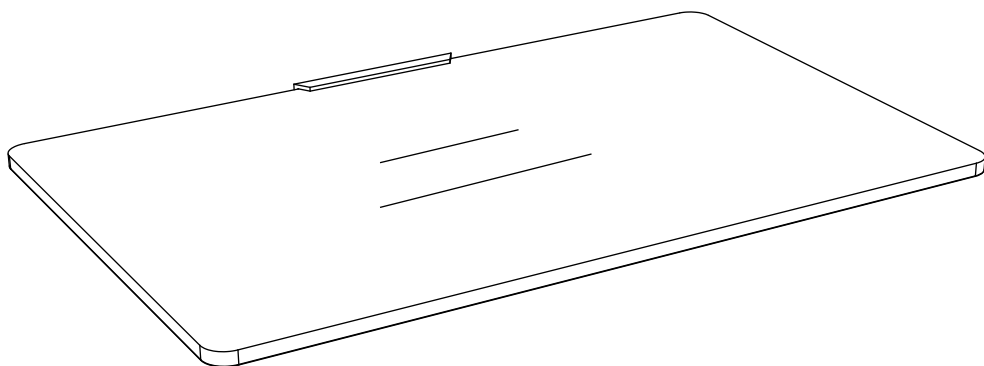
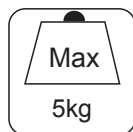

----- INSTALLATION SPECIFICATION:

1

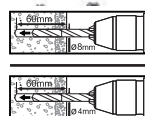

Betonfal

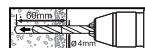

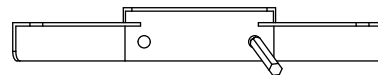

Gipszkarton/Fa fal



—Fúrjon a falba $\Phi 6$ lyukakat az előre bejelölt helyen. A lyukak mélysége legalább 60 mm legyen

2

A		2
B		2
C		2

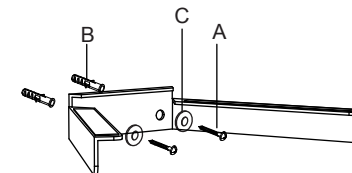

—Az A és B tipli csavarokkal, alátéttel rögzítse a az üvegpalc tartóját.

3

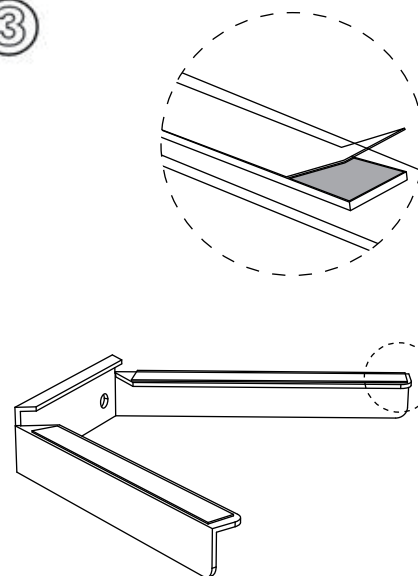

4

